



anywhere  
fireplace®

.....  
ambiance of fire... anywhere

[www.anywherefireplace.com](http://www.anywherefireplace.com)

Devco LLC  
Larchmont, NY

This product has been designed for your enjoyment. Please carefully read all warnings and installation instructions before use.

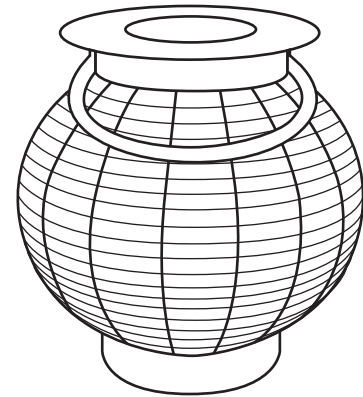

Jupiter  
Model: 90240

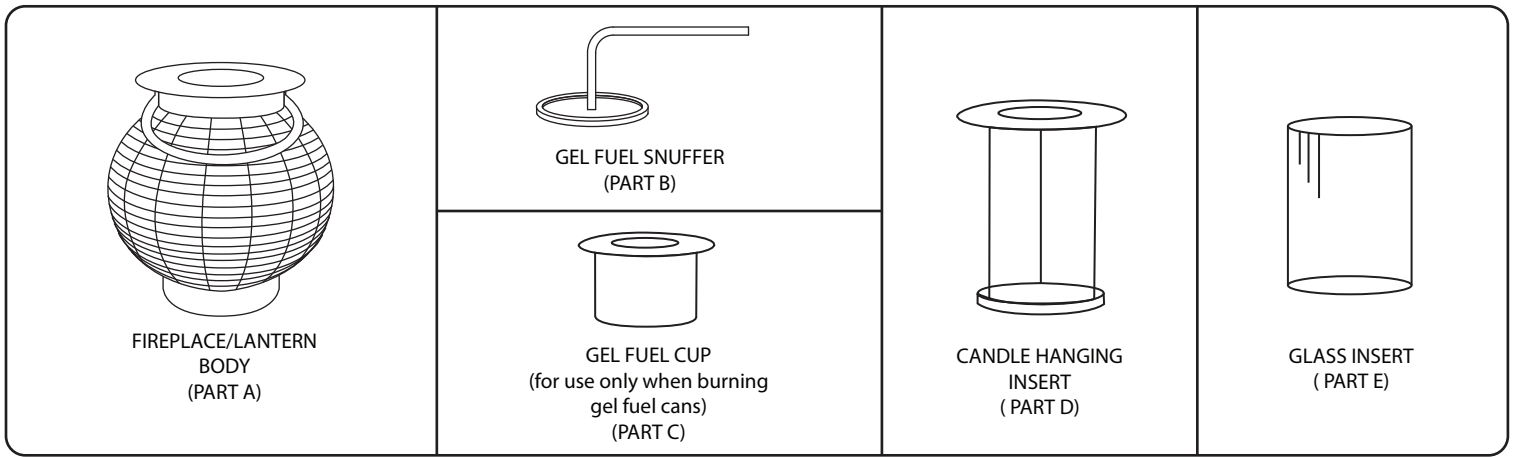

## ANYWHERE FIREPLACE™

The very unique and exciting **2in1** design of these **Anywhere Fireplace® OR Lantern** series gives you the option to either use one as a GEL FUEL fireplace that will give you beautiful dancing flames OR by switching out the cup for the candle holder, use it as a lantern. As a lantern, just insert a candle into the candle holder or just wind fairy lights in the body, flip up the handle and hang it up on a secure hook or place it on a table or floor to give you the romance of flickering tea light or candles or the magical festive sparkle of fairy lights.

The striking hand woven premium nickel plated wire and polished stainless steel designs of this fireplace or lantern will make a dramatic statement whichever way you choose to use it and anywhere you will place it, indoors, but especially outdoors. It is ideal for formal occasions, such as weddings and versatile enough to create dazzle for other gatherings, such as birthday parties, holiday celebration or everyday décor.

These fireplaces are clean burning, so you may use them indoors or out, move it from your house to your outdoor oasis.

### FIREPLACE USE:

When using as a Fireplace, Only use 13Oz Gel Fuel Cans made specifically for ventless fireplaces. Note, there are Gel Fuel cans on the market that have citronella oil in them. If using the Gel Can with Citronella Oil, it can only be used outdoors. A Gel Can will burn approximately 2.5 hours. The wider lip on the GEL Can cup was designed to not allow you to pick up the handle.

### LANTERN USE:

If using as a Lantern with candles, please make sure you put your candle with glass cylinder on the candle holder and lower it through the top. When used as a Lantern with fairy lights, remove both cup and candle holder.

### DISCLAIMER:

While the fireplace/lantern is made of high quality metal and coated to withstand outdoor temperatures, if it is being used near salt water ocean environments, it may rust, so it is recommended that at the end of the period of use, bring it indoors.

### QUESTIONS

KEEP THESE INSTRUCTIONS HANDY AND MAKE SURE ANYONE WHO WILL BE USING THIS FIREPLACE HAS READ ALL OF SAFETY INFORMATION AND HOW TO PROPERLY OPERATE THIS FIREPLACE. For any questions related to parts, assembly, safety or operation visit us on the web at [www.anywherefireplaces.com](http://www.anywherefireplaces.com) or email us at [info@anywherefireplace.com](mailto:info@anywherefireplace.com) or call 914-834-5855.

# WARNING

As a fireplace, it is meant for use ONLY with 13 oz. Gel Fuel Cans made specifically for ventless fireplaces.

NOTE: Some GEL fuel cans on the market may offer a version that contains citronella oil in them as a mosquito deterrent. You may use Gel fuel cans with Citronella Oil however, if you choose to do so, remember that CITRONELLA CANS MAY ONLY BE USED OUTDOORS as they will produce smoke and soot.

## IMPORTANT SAFETY MEASURES

### WHEN USED AS A FIREPLACE:

- Fireplace is intended to be placed on a level floor or steady surface
- Place your fireplace in a location away from traffic or where it could be tipped or knocked over when in use
- Be sure to keep any flammable materials such as drapes/curtains and any decorations at least 4 ft away from fireplace
- Remove paper or wrapper from your Gel fuel can should it come with any around it.
- Do not place any items on top of or inside the fireplace
- Do not touch or move the fireplace while lit or still hot
- **USE ONLY APPROVED Gel Canisters of fuel made specifically for ventless fireplaces**
- This fireplace will produce heat, but should not be used as a main source of heat
- It is extremely dangerous and forbidden to use any other alcohol or bio-ethanol fuel other than one made for fireplaces
- The cup and fireplace body will be hot during use and remain hot for 15 minutes after use, please don't touch.
- The neck of the cup is intentionally large so that the handle of the fireplace cannot be lifted. Do not touch or lift the handle when used as a fireplace as it will be hot
- Make sure the fire is extinguished by placing the provided snuffer over the cup when finished being used or before replacing can
- Never Touch or Replace Gel fuel can while it still hot. Only discard the can in the garbage once it is cool.
- Do not ingest bio-ethanol fuel and avoid contact with eyes and skin
- Be sure to not spill any fuel outside of the can. If you do spill, make sure to wipe up all spillage before igniting the fire
- Only use a long BBQ lighter or long match to ignite the gel fuel can
- Be sure to have a fire extinguishing device in the proximity of the fireplace in case of emergencies
- Never leave a lit fireplace unattended
- Be sure to keep children and pets away from the fireplace while lit and while still hot after extinguishing
- Never smoke near the fuel or leave the fuel near an open flame source
- Store your fuel containers away from any heat source
- Be sure to store and keep your fuel away and out of reach of children and pets
- To extinguish the flame, place the disc of the snuffer over the cup and wait 10 seconds to make sure the flame is out
- It is forbidden to modify this fireplace in any way

### FIREPLACE FUEL INFORMATION

- ONLY Burn Gel Fuel Cans in this Fireplace that are specifically made for ventless fireplaces If the can has any paper labels or other material on it, be sure to remove this before first use
- Please contact us if you have any questions at 914-834-5855 or [info@anywherefireplace.com](mailto:info@anywherefireplace.com)

### WHEN USED AS A LANTERN WITH CANDLES:

- Be sure to remove the fireplace cup
- First Insert a tea light, votive, pedestal candle made of wax or a flameless electronic version in to the wire candle holder with glass and then insert it into the body
- Only use a long BBQ lighter or long match to ignite the wax candles
- Never leave a lit candle unattended
- The candle holder and lantern body may be hot during use and remain hot for 15 minutes after use, please don't touch
- The lantern is intended to be placed on a level table, floor or steady surface
- If the lantern will be hung, be sure that it is hung on sturdy pole or tree limb and in a way it cannot tip, be knocked into or fall off
- Do not touch or move the lantern while lit or still hot

### WHEN USED AS A LANTERN WITH FAIRY LIGHTS

- Remove both fuel cup or candle holder before putting Fairy lights into the body of the lantern
- Do not put anything other than the fairy lights and its battery pack into the body

## ASSEMBLY INSTRUCTIONS FOR USE AS A FIREPLACE

### STEP 1

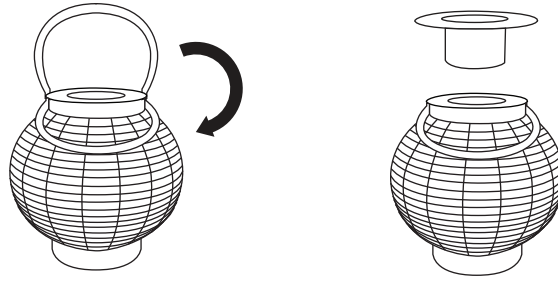

Lower handle on fireplace body and Insert Gel Fuel cup (Part C) into Main Body (part A). NOTE: The rim of the Gel Fuel Cup will be wider than the top of the main body to prevent the handle from being able to be lifted while in use. When in use, make sure you place the fireplace in a location away from traffic so it cannot be tipped or knocked over. ALWAYS KEEP AWAY FROM CHILDREN AND PETS AND AWAY FROM FLAMABLE MATERIALS.

### STEP 2

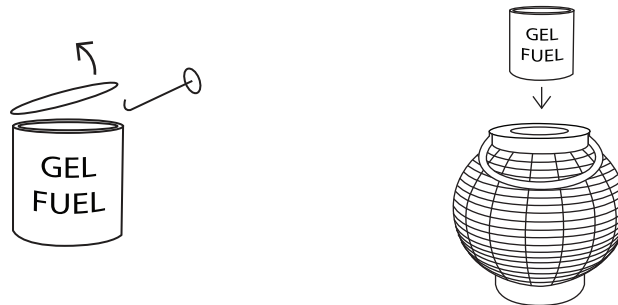

Unwrap any paper labels from around your GEL CAN FUEL if it should have any wrapped around it. Remove the lid from your Gel Fuel can, using a paint can opener or other similar device. Be careful to not puncture the can when you remove the lid. Once the lid is removed, place the can into the cup of your fireplace. Make sure no fuel has spilled out of the can. If it has, clean all of it up before you attempt to light the fuel.

### STEP 3

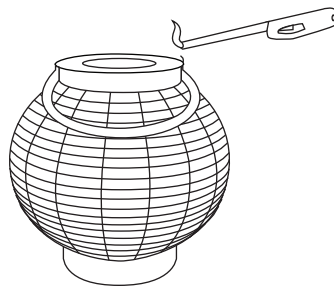

Using a long BBQ style lighter or long match, touch the flame to the fuel and it will ignite... Then ENJOY! BE SURE YOU READ ALL OF THE SAFETY INSTRUCTIONS AND WARNINGS BEFORE USE. ANYONE WHO WILL BE USING THIS FIREPLACE MUST ALSO READ THESE SAFETY AND WARNING INSTRUCTIONS

### STEP 4

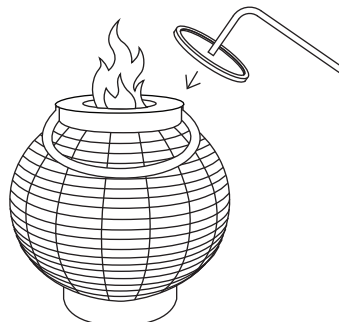

To extinguish the flame, use the snuffer (part B) by placing it over the cup and cutting off the air to the flame. To be sure the fire is extinguished, be sure to leave the snuffer over the cup for at least 10 seconds. Always double check the fire is extinguished before leaving it unattended. Once cool, approx. 10 minutes, you can replace the lid of the can if there is fuel remaining in the can and you intend to reuse the fuel. If the fuel can is empty, be sure the can is cool before discarding it into the garbage.

## ASSEMBLY INSTRUCTIONS FOR USE AS A LANTERN WITH CANDLES

### STEP 1

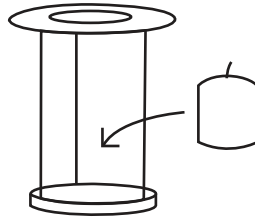

While the Candle Hanging Insert (Part D) is on a level surface or holding it in your hand, place your candle (up to 3" diameter) into the bottom of the insert. NOTE: Make sure your candle wick is properly trimmed to prevent smoke and uneven melting. Battery operated candles can also be used.

### STEP 2

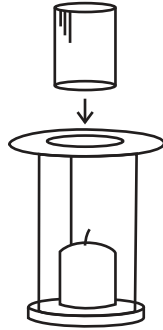

Carefully Lower the Glass Cylinder (Part E) through the top hole in the Candle Hanging Insert (Part D). You will need 2 hands to hold the glass insert above the Insert while lowering it and to catch it once inserted into the hole to keep it from dropping.

### STEP 3

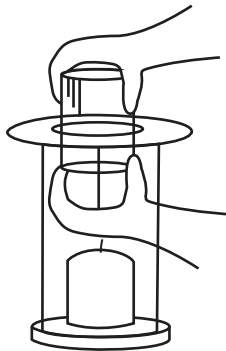

Lower the candle hanging insert with the candle and the glass into the main body.

### STEP 4

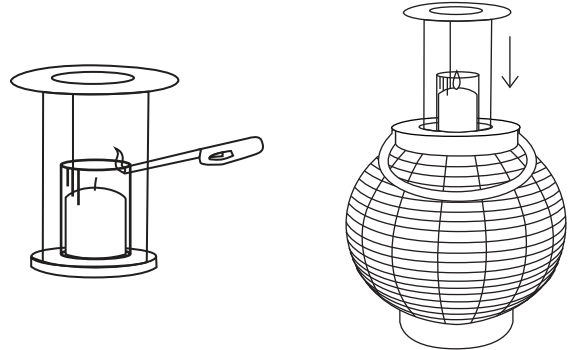

Using a long BBQ lighter, light your candle before you insert it into the Main Body. (Part A)

### STEP 5

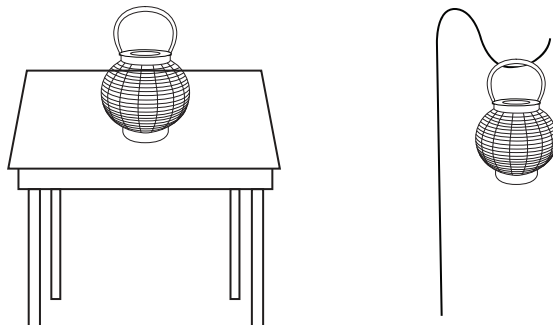

Place the lantern on any steady surface away from children and pets. You can also hang your lantern on a metal hook with the attached handle.

**CAUTION: The lantern handle may get hot if your candle is tall and the flame is high. Extinguish the candle before you grab or touch the handle and allow a few moments to cool.**

**Never place your lantern near Children, Pets or Flammable Materials.**

**Never leave a candle lit while unattended.**

## WARNINGS FOR USE OF FIRE GEL FUEL

# STOP

Please read safety instructions thoroughly



## DANGER

### VERY FLAMMABLE/TRES INFLAMMABLE

**WARNING! FLAMMABLE! IRRITANT!**

**IMPROPER USE AND HANDLING MAY CAUSE PROPERTY DAMAGE, SERIOUS INJURY OR DEATH! HARMFUL IF SWALLOWED!  
READ AND FOLLOW ALL INSTRUCTIONS. FAILURE TO DO SO MAY RESULT IN PROPERTY DAMAGE, SERIOUS INJURY, OR DEATH!**

#### PROPER PRODUCT USE:

- Use only in a well-ventilated area. Do not inhale fumes. Do not smoke near fuel gel.
- Keep away from open flames such as pilot lights or any object that sparks such as electric motors.
- Discharge static electricity before handling.
- Wear eye protection during ignition process.
- Do not allow children or pets near open flames.
- Do not touch or move device while flames are present. Allow 20 minutes for device to cool before handling.
- Gel canisters are designed for single use only. Never attempt to refill.
- Limit use to adults 18 years of age and older.
- Keep children and pets safely clear of device particularly when flames are present.
- Severe burns or injury may result from improper contact with device or fuel gel.
- Use only an extended wand lighter to ignite gel fuel.
- Do not obstruct or inhibit flame by placing anything on or above device.
- Do not use for cooking.
- Do not mix fuel with any other substance.
- Use lid snuffer tool to extinguish flame.

#### FIRST AID TREATMENT:

- Fuel contains isopropanol.
- If swallowed call poison control center at 800-222-1222, 911, hospital or doctor immediately.
- If swallowed dilute by drink lots of water. **Do not induce vomiting.**
- If fuel spills on skin immediately wash with soap and water. If fuel gets in eyes rinse with cool water.
- If inhaled move into fresh air immediately.
- If fuel spills on clothes remove as soon as possible and wash.
- **If symptoms from exposure persists consult a doctor immediately.**
- Gel canisters are designed for single use only. Do not attempt to refill.
- If fire is extinguished before fuel is gone, let stand for at least 20 minutes before attempting to reignite. Once can is cool, follow gel can ignition procedures.
- **If spill results in fire, use CO<sub>2</sub> extinguisher or baking soda to extinguish flames.**